



**MIKAPEN**

Porte D'entrée  
**Aluminium et PVC**



[www.mikapen.net](http://www.mikapen.net)

3 ?

4 Caractéristiques

### **Porte PVC / Aluminium**

7  
IDEAL 4000  
IDEAL 4000 SMART  
EKO 30  
SENCE 64  
DYNAMIC 68  
ADVANCE 77

20 Accessoires

23 Nos Projets et Realisations

27 Notre Usine





# LE CHOIX DE VOTRE PORTE / PVC

## IDEAL 4000

- Construites sur le profilé multi-chambre, de 70 mm d'épaisseur, avec un seuil bas en aluminium avec rupture point thermique, nos portes d'entrée possèdent de très bons paramètres d'isolation thermique et phonique.
- De plus, nos portes d'entrées pvc sont équipées des renforts en acier solide ce qui donne les paramètres statiques excellents.
- L'utilisation du seuil aluminium de 20mm permet une circulation facile.
- Le rejet d'eau facilite l'évacuation de l'eau vers l'extérieur.
- Il y a une possibilité d'installation de différents vitrages et panneaux de l'épaisseur de 24 et 36 mm.

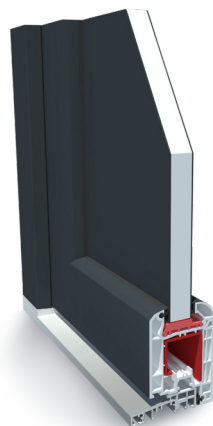
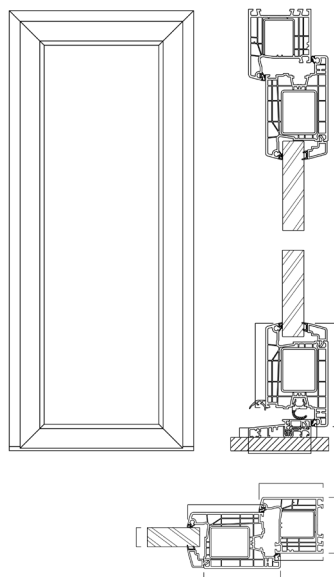

Ideal 4000

## IDEAL 4000 SMART

- Vantail de porte extérieur 85 mm
- Tige commandée KfV 5 broches 35/92
- Poignée de porte à pression intérieure
- Poignée suspendue 1400 (longueur verre)
- Joint de seuil
- charnière 3D
- Baril de technologie verte
- Goupille de sécurité 3 pièces sur le joint
- Seuil en aluminium 20 x 70
- Panneau sous forme de motif

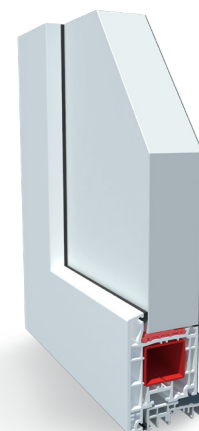
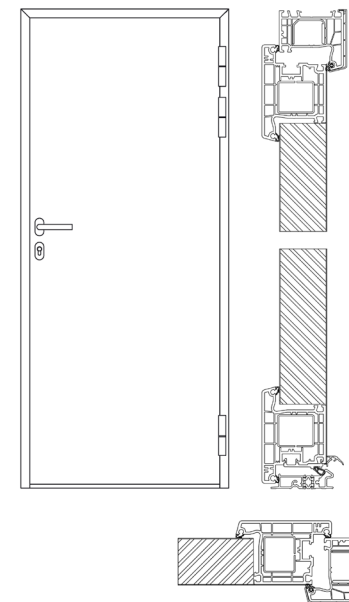

Ideal 4000 Smart  
(Côté arrière de la porte)

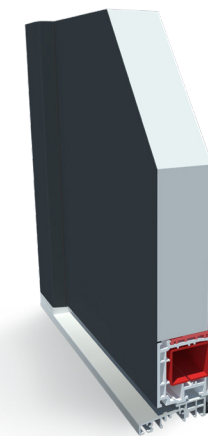

Ideal 4000 Smart  
(Devant la porte)



# LE CHOIX DE VOTRE PORTE / ALUMINIUM

## PORTE EKO

- Panneaux de 64 mm acier composé de polystyrène extrudé (XPS)
- Laquage label Qualicoat / Qualimarine / Qualanod
- Triple vitrages 4 HST SATÏNE / 22 / 44.2 / 22 / 4 HST SATÏNE
- Ouvrant R-P.TH barrette polyamide renforcée de fibres de verre, profil sans pareclose
- Serrure 5 points de fermeture crémone
- Paumelle à clamors 80kg
- Cylindre européen avec trois clefs
- Dormant 78 mm RPTH barrette polyamide renforcée de fibres de verre, système intégré d'habillage extérieur ou de tapée
- Triple joint sur le système d'ouverture
- Seuil à rupture de pont thermique PMR anodisé
- Système de rejet d'eau anodisé - Équerre de serrage par compression vissée, équerrage des angles par équerre inox ouvrant et dormant
- Profil pouvant accepter une tapée d'isolation et une aile de recouvrement intérieure
- Option panneaux alu
- Poignée intérieur extérieur inox standart.

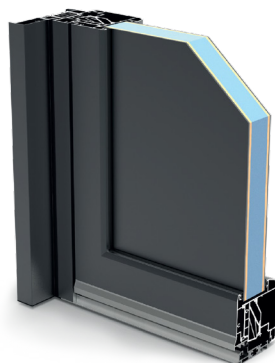
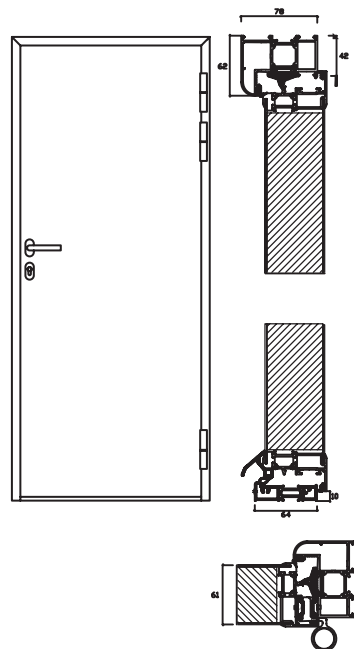

## PORTE ALUMINYUM SENCE

- Panneaux de 32mm composé de polystyrène extrudé (XPS), ou verre 44.2 / 16 / 44.2 FE, GAZ
- Parement aluminium de 1,00 mm
- Laquage label Qualicoat / Qualimarine / Qualanod
- Double vitrages 4 HST SATÏNE / 18 / 44 2 SATÏNE
- Ouvrant R-P.TH barrette polyamide renforcée de fibres de verre, profil sans pareclose
- Serrure 5 points de fermeture crémone
- Paumelle à clamors 80kg
- Cylindre européen avec trois clefs
- Dormant 78 mm RPTH barrette polyamide renforcée de fibres de verre, système intégré d'habillage extérieur ou de tapée
- Triple joint sur le système d'ouverture
- Seuil à rupture de pont thermique PMR anodisé
- Système de rejet d'eau anodisé - Équerre de serrage par compression vissée, équerrage des angles par équerre inox ouvrant et dormant
- Profil pouvant accepter une tapée d'isolation et une aile de recouvrement intérieure
- Poignée intérieur extérieur inox standart

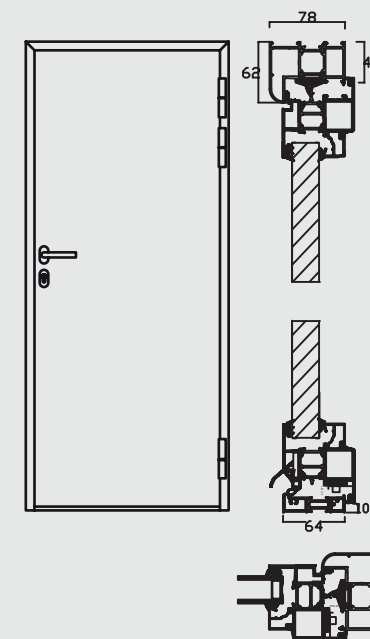

# LE CHOIX DE VOTRE PORTE / ALUMINIUM

## PORTE ALUMINYUM DYNAMIC

- Systeme : Reynaers CS77
- Ouvrant monobloc 68mm
- Parement aluminium extérieur 1,5 mm, intérieur 2,00 mm
- Laquage label Qualicoat / Qualimarine / Qualanod
- Triple vitrages 4 HST SATÏNE / 22 / 44.2 / 22 / 4 HST SATÏNE
- Ouvrant R-P.TH barrette polyamide renforcée de fibres de verre, profil sans pareclose
- Serrure avec trois points de fermeture crochet
- Paumelle à réglage 3D, résistance 120kg
- Cylindre européen avec trois clefs
- Dormant 68 mm RPTH barrette polyamide renforcée de fibres de verre, système intégré d'habillage extérieur ou de tapée
- Triple joint sur le système d'ouverture
- Seuil à rupture de pont thermique PMR anodisé
- Système de rejet d'eau anodisé - Équerre de serrage par compression vissée, équerrage des angles par équerre inox ouvrant et dormant
- Profil pouvant accepter une tapée d'isolation et une aile de recouvrement intérieure
- Poignée intérieur extérieur inox standart.

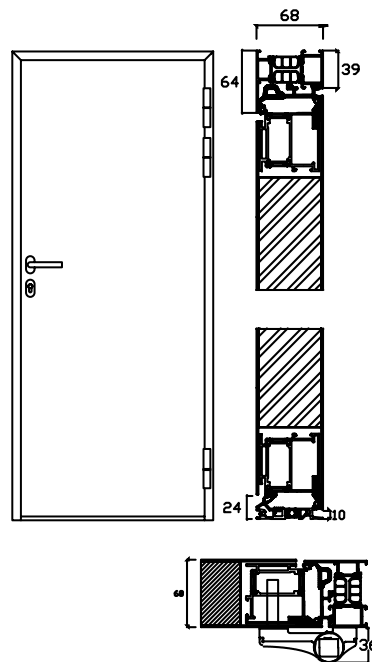

## PORTE ALUMINYUM ADVANCE

- Systeme : REYNAERS MASTERLINE 8
- Ouvrant monobloc 77mm
- Parement aluminium extérieur 1,5 mm, intérieur 2,00 mm
- Laquage label Qualicoat / Qualimarine / Qualanod
- Quadruple vitrages 4 HST SATÏNE / 16 / 4HST / 16 / 44.2 / 18 / 4 HST SATÏNE
- Ouvrant R-P.TH barrette polyamide renforcée de fibres de verre, profil sans pareclose
- Serrure avec trois points de fermeture crochet
- Paumelle à réglage 3D, résistance 120kg
- Cylindre européen avec trois clefs
- Dormant 77 mm RPTH barrette polyamide renforcée de fibres de verre, système intégré d'habillage extérieur ou de tapée
- Triple joint sur le système d'ouverture
- Seuil à rupture de pont thermique PMR anodisé
- Système de rejet d'eau anodisé - Équerre de serrage par compression vissée, équerrage des angles par équerre inox ouvrant et dormant
- Profil pouvant accepter une tapée d'isolation et une aile de recouvrement intérieure
- Poignée intérieur extérieur inox standart

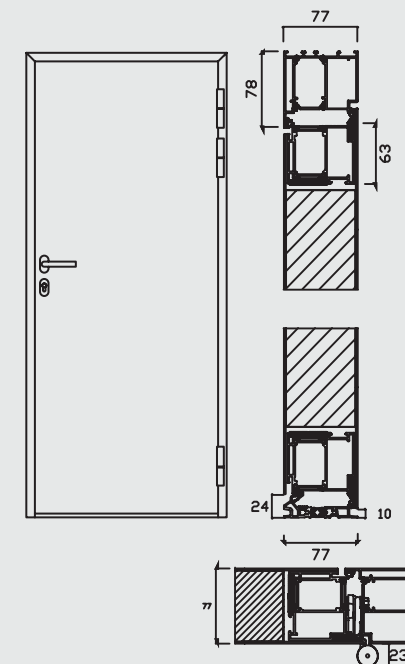

## LE CHOIX DE VOTRE PORTE PVC



### 5 POINTS de FERMETURE

5 clés à points réversibles  
Carte de reproduction  
Protection anti-perçage renforcée  
Débrayable: il permet de laisser une clé dans le canon à l'intérieur sans gêner l'ouverture de l'extérieur.



# LE CHOIX DE VOTRE PORTE ALUMINIUM / PVC

Mika 201  
IDEAL 4000  
EKO 30



Mika 202  
IDEAL 4000  
EKO 30

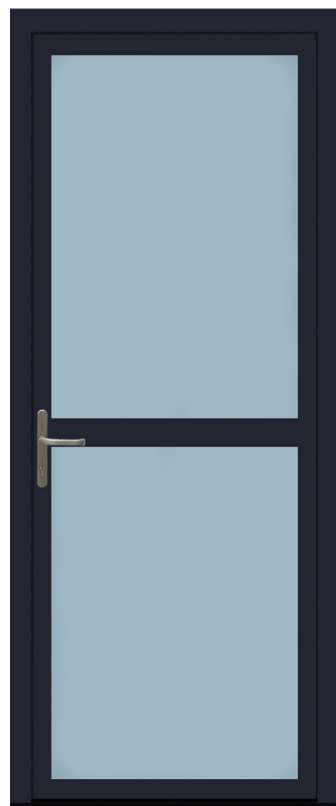

Mika 203  
IDEAL 4000  
EKO 30



Mika 204  
IDEAL 4000  
EKO 30

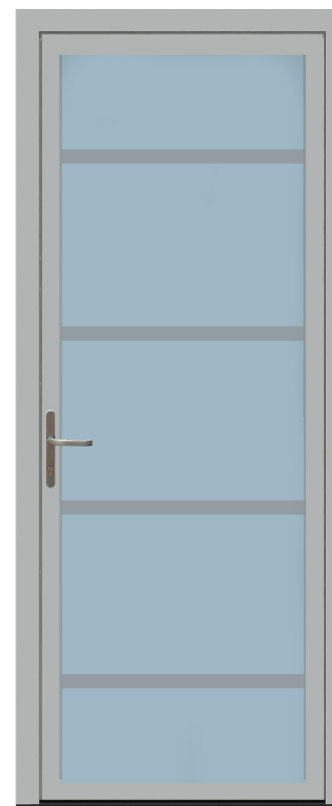

Mika 205  
IDEAL 4000  
EKO 30





# LE CHOIX DE VOTRE PORTE ALUMINIUM / PVC

## Mika 301

IDEAL 4000  
IDEAL 4000 SMART  
EKO 30  
SENCE 64  
DYNAMIC 68  
ADVANCE 77



## Mika 302

IDEAL 4000  
IDEAL 4000 SMART  
EKO 30  
SENCE 64  
DYNAMIC 68  
ADVANCE 77



## Mika 303

IDEAL 4000  
IDEAL 4000 SMART  
EKO 30  
SENCE 64  
DYNAMIC 68  
ADVANCE 77



## Mika 304

IDEAL 4000  
IDEAL 4000 SMART  
EKO 30  
SENCE 64  
DYNAMIC 68  
ADVANCE 77

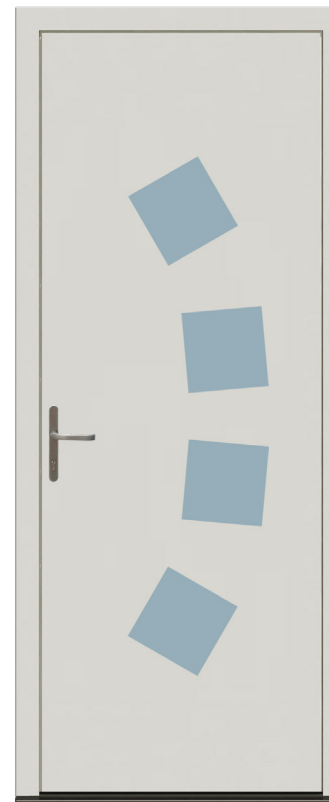

## Mika 305

IDEAL 4000  
IDEAL 4000 SMART  
EKO 30  
SENCE 64  
DYNAMIC 68  
ADVANCE 77



# LE CHOIX DE VOTRE PORTE ALUMINIUM / PVC

## Mika 306

IDEAL 4000  
IDEAL 4000 SMART  
EKO 30  
SENCE 64  
DYNAMIC 68  
ADVANCE 77

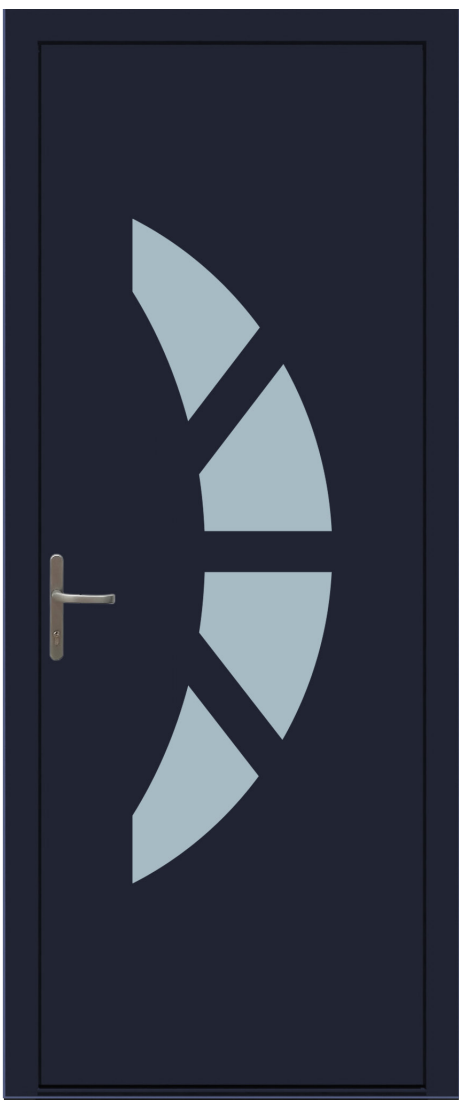

## Mika 307

IDEAL 4000  
IDEAL 4000 SMART  
EKO 30  
SENCE 64  
DYNAMIC 68  
ADVANCE 77



## Mika 308

IDEAL 4000  
IDEAL 4000 SMART  
EKO 30  
SENCE 64  
DYNAMIC 68  
ADVANCE 77



## Mika 309

IDEAL 4000  
IDEAL 4000 SMART  
EKO 30  
SENCE 64  
DYNAMIC 68  
ADVANCE 77

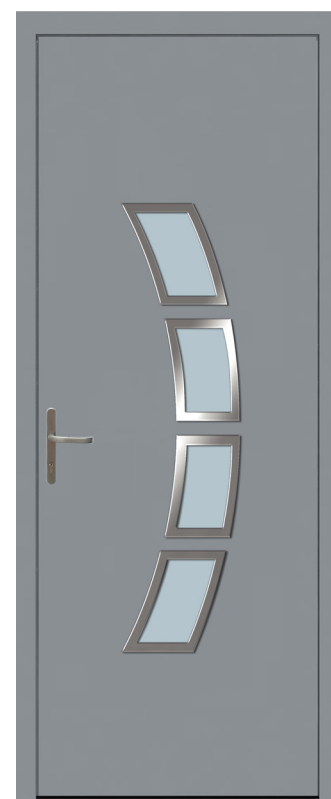

## Mika 310

IDEAL 4000  
IDEAL 4000 SMART  
EKO 30  
SENCE 64  
DYNAMIC 68  
ADVANCE 77



# LE CHOIX DE VOTRE PORTE ALUMINIUM / PVC

## Mika 311

IDEAL 4000  
IDEAL 4000 SMART  
EKO 30  
SENCE 64  
DYNAMIC 68  
ADVANCE 77



## Mika 312

IDEAL 4000  
IDEAL 4000 SMART  
EKO 30  
SENCE 64  
DYNAMIC 68  
ADVANCE 77



## Mika 313

IDEAL 4000  
IDEAL 4000 SMART  
EKO 30  
SENCE 64  
DYNAMIC 68  
ADVANCE 77

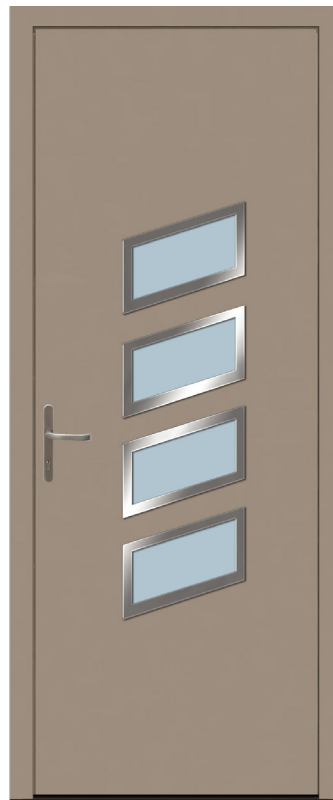

## Mika 314

IDEAL 4000  
IDEAL 4000 SMART  
EKO 30  
SENCE 64  
DYNAMIC 68  
ADVANCE 77



## Mika 315

IDEAL 4000  
IDEAL 4000 SMART  
EKO 30  
SENCE 64  
DYNAMIC 68  
ADVANCE 77



# LE CHOIX DE VOTRE PORTE ALUMINIUM / PVC

## Mika 316

IDEAL 4000  
IDEAL 4000 SMART  
EKO 30  
SENCE 64  
DYNAMIC 68  
ADVANCE 77

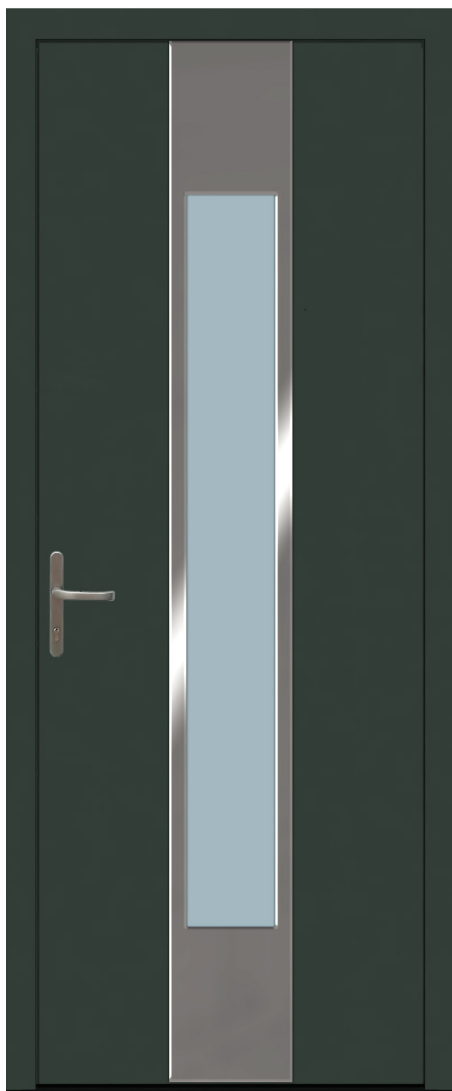

## Mika 317

IDEAL 4000  
IDEAL 4000 SMART  
EKO 30  
SENCE 64  
DYNAMIC 68  
ADVANCE 77

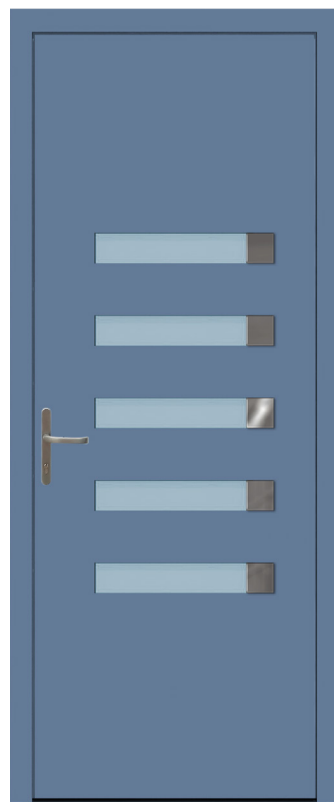

## Mika 318

IDEAL 4000  
IDEAL 4000 SMART  
EKO 30  
SENCE 64  
DYNAMIC 68  
ADVANCE 77



## Mika 319

IDEAL 4000  
IDEAL 4000 SMART  
EKO 30  
SENCE 64  
DYNAMIC 68  
ADVANCE 77

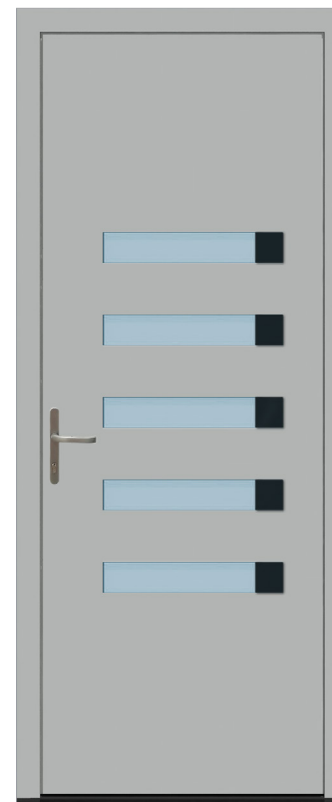

## Mika 320

IDEAL 4000  
IDEAL 4000 SMART  
EKO 30  
SENCE 64  
DYNAMIC 68  
ADVANCE 77



# LE CHOIX DE VOTRE PORTE ALUMINIUM / PVC

## Mika 321

IDEAL 4000  
IDEAL 4000 SMART  
EKO 30  
SENCE 64  
DYNAMIC 68  
ADVANCE 77



## Mika 322

IDEAL 4000  
IDEAL 4000 SMART  
EKO 30  
SENCE 64  
DYNAMIC 68  
ADVANCE 77



# LE CHOIX DE VOTRE PORTE ALUMINIUM / PVC

## Mika 401

IDEAL 4000 SMART  
EKO 30  
SENCE 64  
DYNAMIC 68  
ADVANCE 77

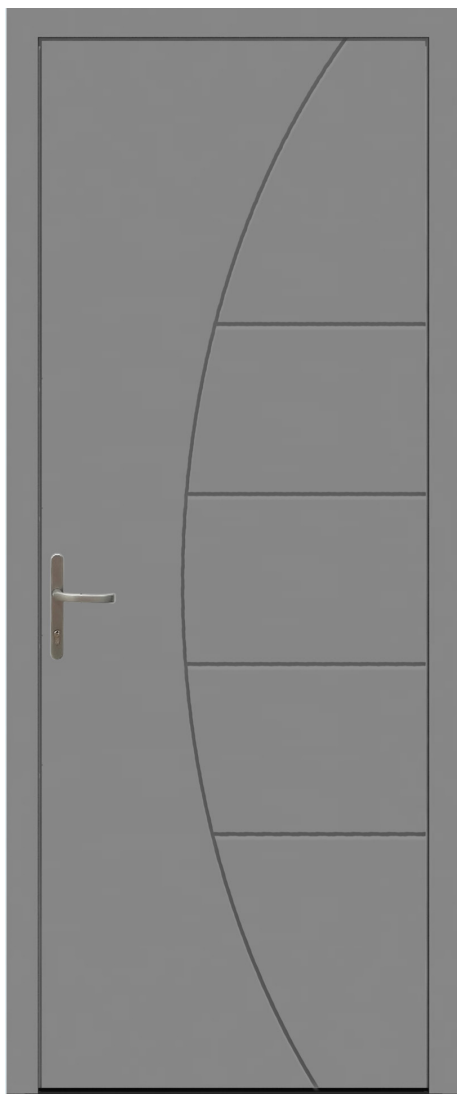

## Mika 402

IDEAL 4000 SMART  
EKO 30  
SENCE 64  
DYNAMIC 68  
ADVANCE 77

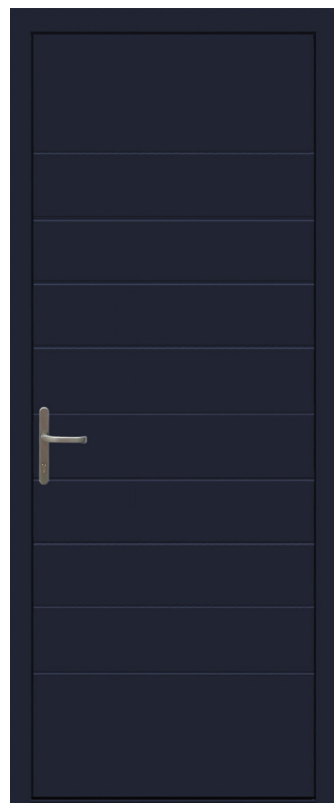

## Mika 403

IDEAL 4000 SMART  
EKO 30  
SENCE 64  
DYNAMIC 68  
ADVANCE 77



## Mika 404

IDEAL 4000 SMART  
EKO 30  
SENCE 64  
DYNAMIC 68  
ADVANCE 77



## Mika 405

IDEAL 4000 SMART  
EKO 30  
SENCE 64  
DYNAMIC 68  
ADVANCE 77



# LE CHOIX DE VOTRE PORTE ALUMINIUM / PVC

## Mika 406

IDEAL 4000 SMART  
EKO 30  
SENCE 64  
DYNAMIC 68  
ADVANCE 77

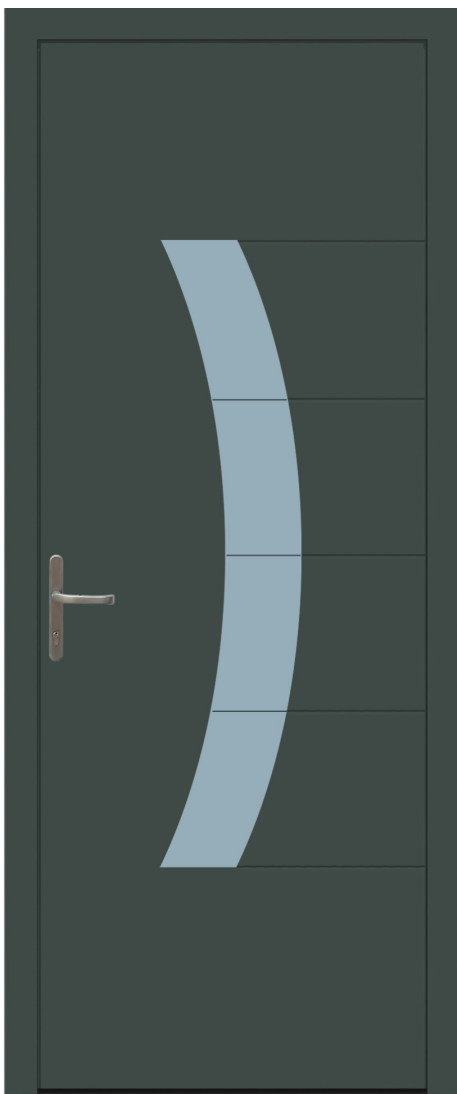

## Mika 407

IDEAL 4000 SMART  
EKO 30  
SENCE 64  
DYNAMIC 68  
ADVANCE 77

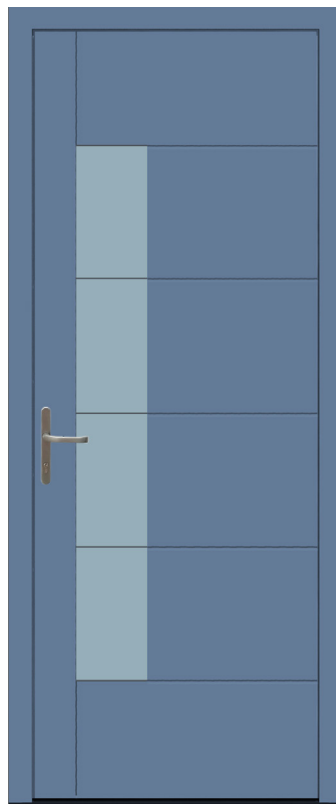

## Mika 408

IDEAL 4000 SMART  
EKO 30  
SENCE 64  
DYNAMIC 68  
ADVANCE 77

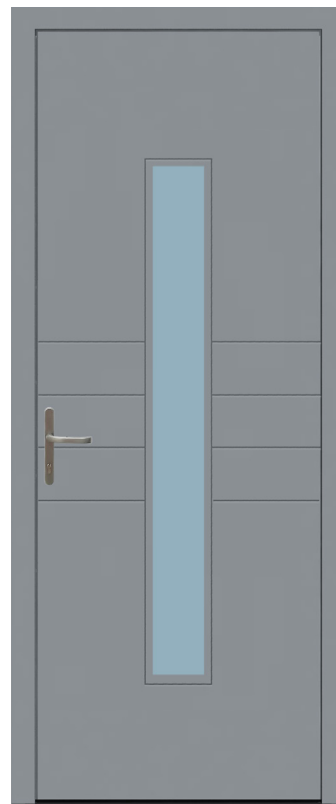

## Mika 409

IDEAL 4000 SMART  
EKO 30  
SENCE 64  
DYNAMIC 68  
ADVANCE 77

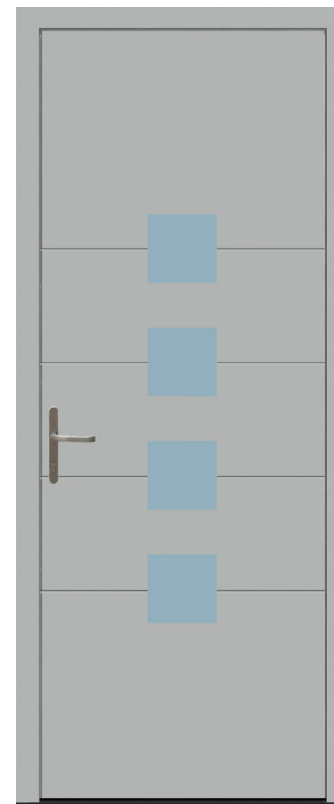

## Mika 410

IDEAL 4000 SMART  
EKO 30  
SENCE 64  
DYNAMIC 68  
ADVANCE 77

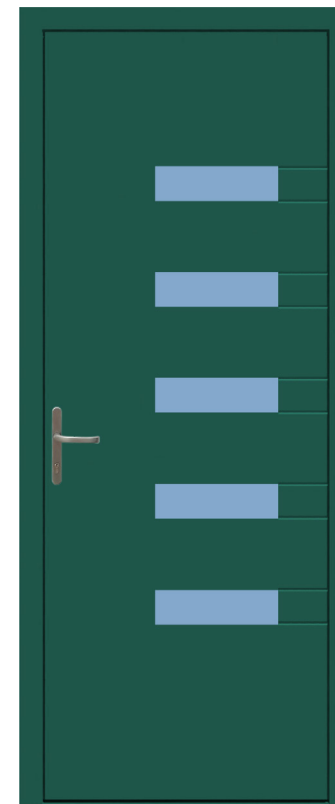

# LE CHOIX DE VOTRE PORTE ALUMINIUM / PVC

## Mika 411

IDEAL 4000 SMART  
EKO 30  
SENCE 64  
DYNAMIC 68  
ADVANCE 77



## Mika 412

IDEAL 4000 SMART  
EKO 30  
SENCE 64  
DYNAMIC 68  
ADVANCE 77

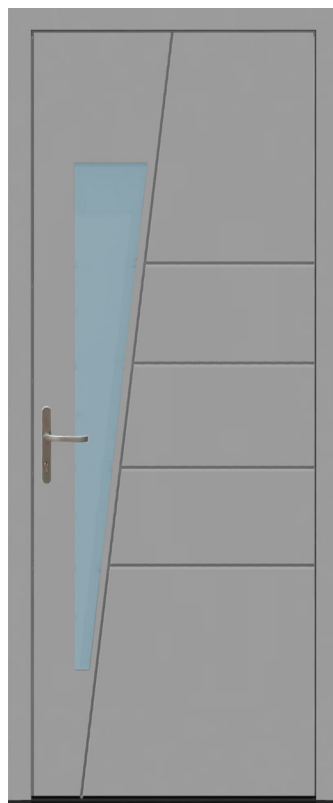

## Mika 413

IDEAL 4000 SMART  
EKO 30  
SENCE 64  
DYNAMIC 68  
ADVANCE 77

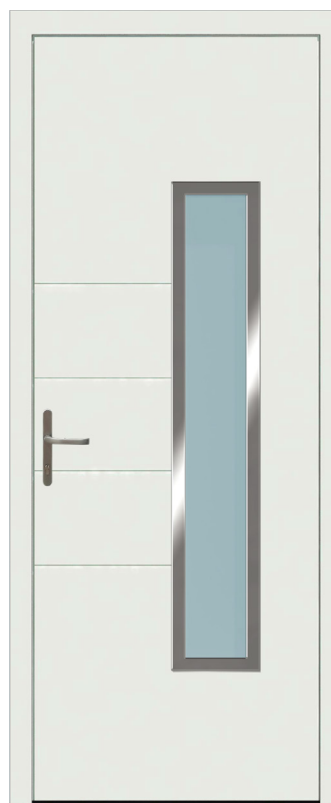

## Mika 414

IDEAL 4000 SMART  
EKO 30  
SENCE 64  
DYNAMIC 68  
ADVANCE 77

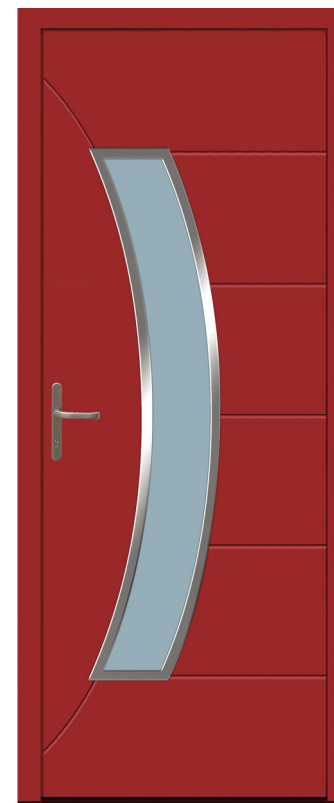

## Mika 415

IDEAL 4000 SMART  
EKO 30  
SENCE 64  
DYNAMIC 68  
ADVANCE 77

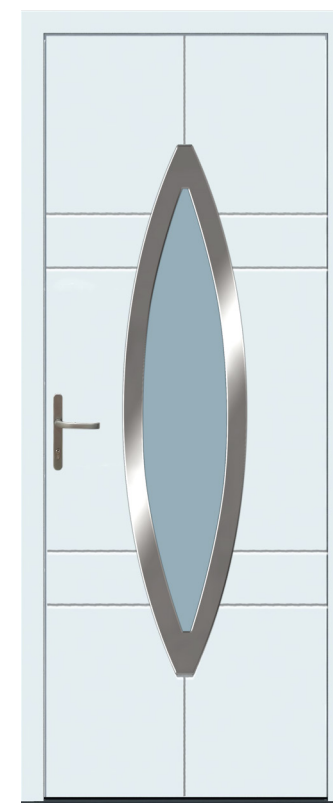



# LE CHOIX DE VOTRE PORTE ALUMINIUM / PVC

**Mika 416**  
IDEAL 4000 SMART  
EKO 30  
SENCE 64  
DYNAMIC 68  
ADVANCE 77



**Mika 417**  
IDEAL 4000 SMART  
EKO 30  
SENCE 64  
DYNAMIC 68  
ADVANCE 77



**Mika 418**  
IDEAL 4000 SMART  
EKO 30  
SENCE 64  
DYNAMIC 68  
ADVANCE 77

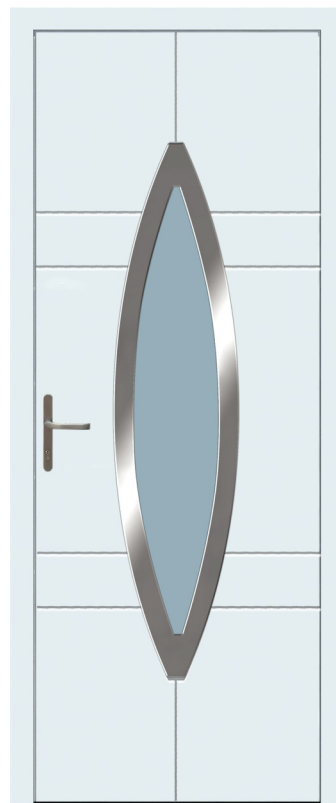

# LE CHOIX DE VOTRE PORTE ALUMINIUM

Mika 501  
DYNAMIC 68  
ADVANCE 77



Mika 502  
DYNAMIC 68  
ADVANCE 77

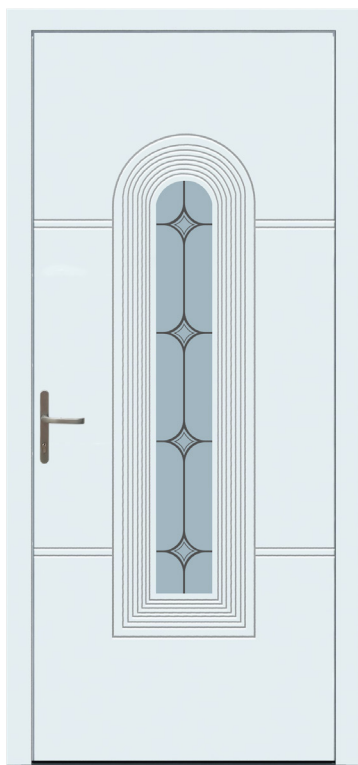

Mika 503  
DYNAMIC 68  
ADVANCE 77



Mika 504  
DYNAMIC 68  
ADVANCE 77



Mika 505  
DYNAMIC 68  
ADVANCE 77



# LE CHOIX DE VOTRE PORTE ALUMINIUM

Mika 506  
DYNAMIC 68  
ADVANCE 77



Mika 507  
DYNAMIC 68  
ADVANCE 77



Mika 508  
DYNAMIC 68  
ADVANCE 77



Mika 509  
DYNAMIC 68  
ADVANCE 77



# ACCESSOIRES DÉCORATIFS POUR PORTES D'ENTRÉE

## Poignées en option



Bâton Maréchale



Bâton Maréchale  
Demi-lune



Bâton Maréchale  
Rustique



Poignée Cuvette  
Encastrable



Bâton de Tirage inox



Poignée Tirant  
Bouton

## Serrure des Crémone



Serrure Crochet

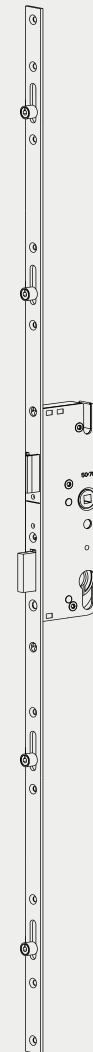

Serrure 5 Point

**SIEGENIA AUBI**  
SOLUTIONS INSIDE

# ACCESSOIRES DÉCORATIFS POUR PORTES D'ENTRÉE

## Accessoires



Ouvertures Électroniques



Cylindre Motorisé



Alarme



LCD Jumelles



Jumelles

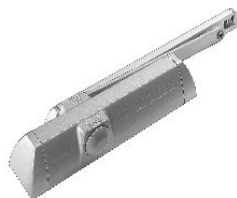

Door Closer



Boites Aux Lettres



## Paumelles



Futura 7100



Reynaers Rollenband



WR-2R



WX 2-Wing, Asymmetrical

# NOS PROJETS ET RÉALISATIONS

## PROFESSIONNELS



”B&B Hôtels”



”Decus Villas”

## PARTICULIERS



# NOTRE USINE





# MIKAPEN

 LIVRY GARDAN  
38, bd l'Europe (93190)  
01 43 30 14 46 - 06 36 19 19 90

 LE MUY  
2204, route d'Aix (83490)  
09 84 06 08 95

 info@mikapen.net / mikapenglobal93@gmail.com

VOTRE INSTALLATEUR

